



Company Presentation

**ESM: YOUR OEM PARTNER FOR PRIVATE LABEL
2026**



Table of contents

About ESM	3	Quality	9
Original Equipment Manufacturer	4	Product Groups	10-15
Our Mission and Vision	5	Surface Treatment	16
Engineering & Sampling	6	Finishing & Packing	17
Main Operations	7	Installation & Application of Our Products	18
Welding	8	Connect with us	19

About ESM

ESM was founded in 2013 under the name Todebo doo as a **subsidiary** of the Dutch company **Todebo BV**. The company was founded as a manufacturing company for:

- **M&E / MEP**
- **HVAC**
- **piping**

installations for the **EU market**. In the year 2020, the name of Todebo was changed to a more representative name which was **ESM (European Strut & Support Manufacturer)**.

As shown on the card on the right, the production is located in **Serbia (30 km from EU border)** but the office of the director, Tom de Boer, is located in the Netherlands (Zeeland). In addition, we have a distribution warehouse in the Netherlands.



- **Netherlands: Office Director & distribution location**
- **Serbia: Production location ESM**
- **Orange pins: customers**



Original Equipment Manufacturer

ESM is an **OEM** which means that we produce for other brands and therefore we do not have a brand ourselves. We produce according to the customer's standards and requirements. After the production has taken place, the products are packed and labelled with or without the customer's brand. By offering this flexibility, we therefore provide both **private label** and **white label** solutions. Through our specialization, we offer small to medium-sized series of high quality fastening materials mainly for **HVAC, M&E** and **piping systems** industries.





Our Mission and Vision

Mission

ESM is dedicated to being a reliable partner for European-made support and fastening products. We focus on quality and lead time in our manufacturing processes, while also ensuring flexibility, short communication lines, and the ability to quickly adapt to our customers' needs.

Vision

Our vision is to be the go-to partner for our customers, supporting them in achieving their goals with innovative, reliable, and high-quality products, while remaining competitive in the European market.

Engineering & Sampling

ESM does not have an engineering department, however, we occasionally receive **physical samples** from customers that need to be **reverse-engineered** (i.e. analyzing product to improve it). We then create concept drawings, either in **2D** or **3D**, and send them to the customer for approval. Once the customer approves the drawings, we proceed with making the samples. After the samples are approved, the item is finalized for production.

Our sequence from samples to FMEA analysis:

**The welding procedure is not included here*

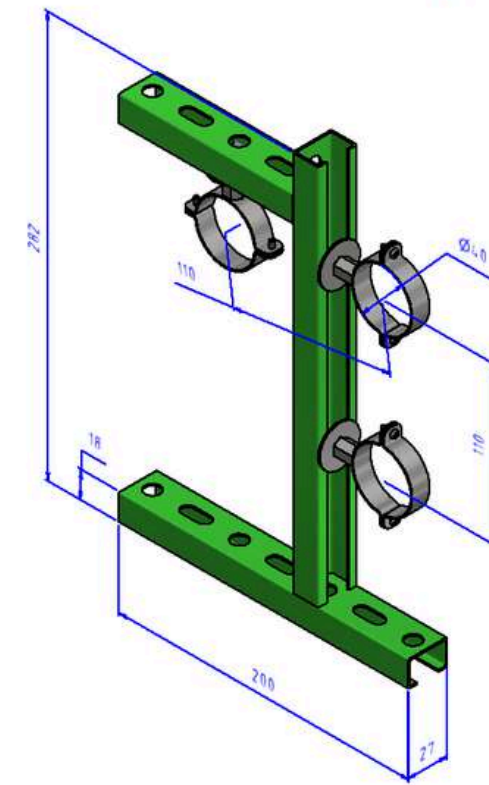
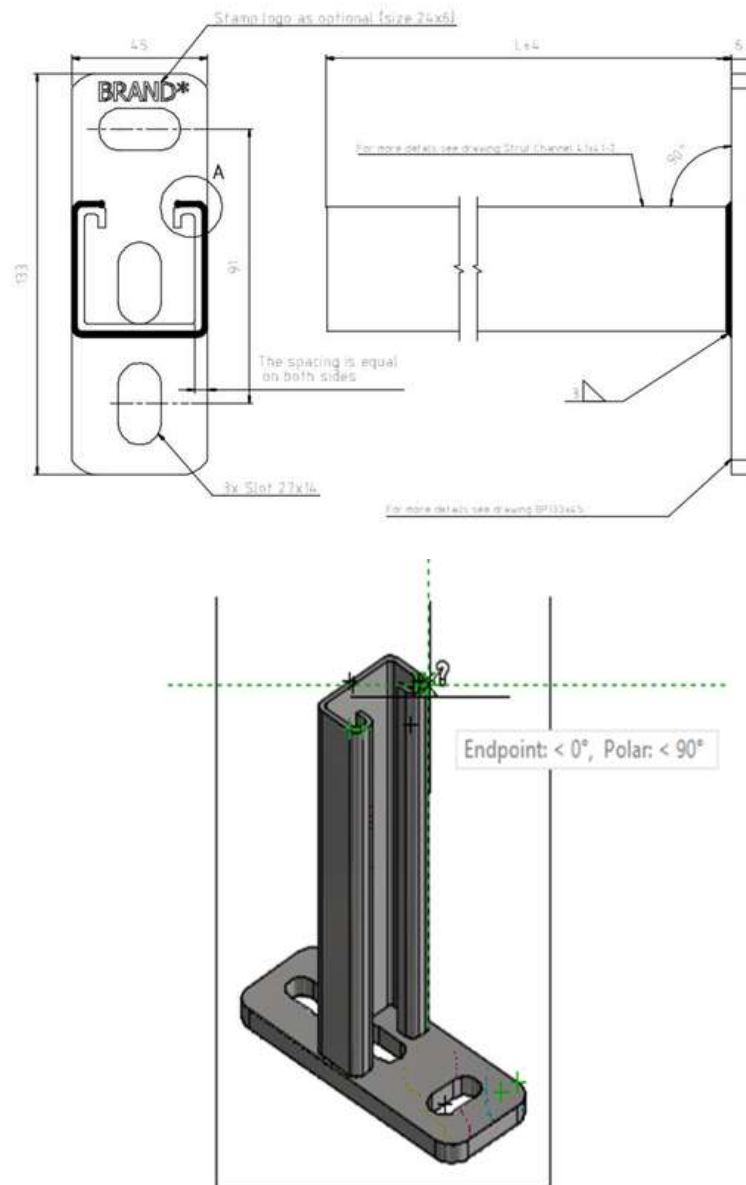

Main Operations

Home Production and outsourcing

Our company performs as much home production as possible to make sure that we meet the customer's quality standards and to provide a better guarantee of lead time to our customers.

Turning & Miller components are being outsourced by approved suppliers.

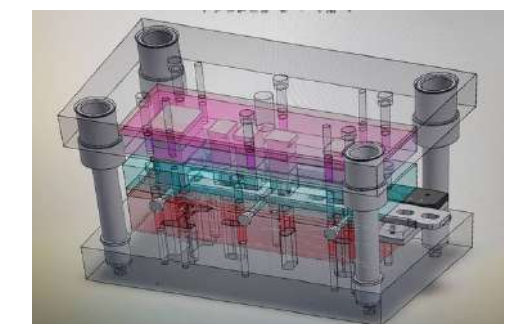
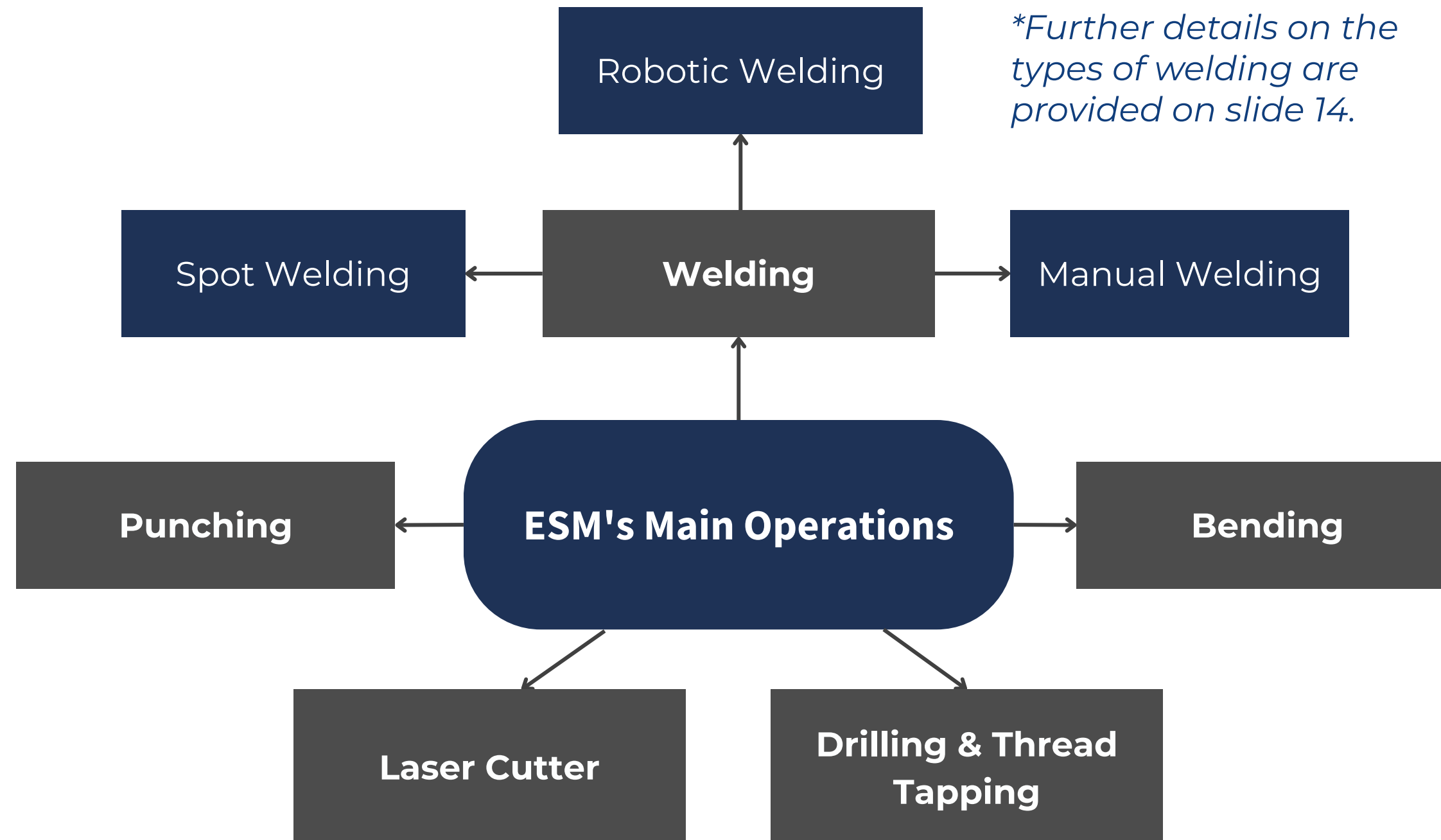

Welding

At **ESM**, welding is a central operation, encompassing MIG/MAG welding with robots, welding manipulators, and manual welding. All of these processes are carried out in strict accordance with our welding standard **ISO 3834** to ensure the highest quality, consistency, and adherence to safety and performance regulations.

Our **International Welding Engineer (IWE)** plays a key role in overseeing and managing the welding processes, particularly for projects that fall under **EXC class 2** of **EN 1090-2**. The **IWE** is responsible for ensuring compliance with welding standards, developing welding procedures, and conducting quality control throughout the process. This includes the preparation and management of the following key documents:

- **(p)WPS** (Pre-Welding Procedure Specification)
- **WPQR** (Welding Procedure Qualification Record)
- **WQR** (Welder Qualification Record)
- **PQR** (Procedure Qualification Record)
- **WPA** (Welding Procedure Approval)



Quality

Throughout the entire process, we have established an **Integrated Management Systems (IMS)**, which includes **ISO 9001, ISO 14001, ISO 45001**, along with **ISO 3834** and **EN 1090-2**, to ensure consistent quality. These systems help track performance, document procedures, and maintain records for traceability.

Testing

Additionally, products can be tested externally by a local, notified body. Testing may include **destructive tests**, such as **bend and tensile tests**, as well as **non-destructive tests**, such as **visual inspection, liquid penetrant testing (PT), ultrasonic testing (UT), and X-ray inspection (RT)**.

	Faculty of Technical Sciences Department of Production Engineering Chair of Materials and Joining Technologies Materials testing laboratory NOVI SAD	0153-3.305/
------------------------------------------------------------------------------------	------------------------------------------------------------------------------------------------------------------------------------------------------------------	-------------

TEST SUBJECT: Cantilever console RHS 80x40x3 (backing plate 150x140x8 mm; channel size 80x40 mm, channel length 414 mm, channel thickness 3 mm)

AIM OF TESTING: Bend testing

TESTING PROCEDURES: Bending at 290 mm from back plate/support

TESTING EQUIPMENT: Tensile testing machine VEB ZDM 5/91, maximum load 50 kN; testing range 10 kN

TESTING RESULTS:
Specimens were subjected to bend testing and displacement measurement as shown in Figure 1. The dependence between loads to displacement charts are presented in Table 1, with comments regarding the behavior of the console.



Figure 1 Testing setup

IZVEŠTAJ ISPITIVANJA PENETRANTIMA PENETRANT TEST REPORT		DONA INSPECT d.o.o. Smederevska Palanka Suvoborska 5		
------------------------------------------------------------	--	------------------------------------------------------------	--	--------------------------------------------------------------------------------------

Izveštaj br.: DI-PT-459/23 List: 2/2
Report No. Pages: 2/2
Prilog: fotografija / Attachment: photo



Anlage 3 Seite 4 von 4 zum Untersuchungsbericht des TÜV SÜD Industrie Service GmbH Prüf-Nr. 0036752-13-23-01-219-004

TÜV SÜD Industrie Service GmbH



GEFÜGEUNTERSUCHUNG - TEXTURE EXAMINATION - EXAMEN DE LA STRUCTURE

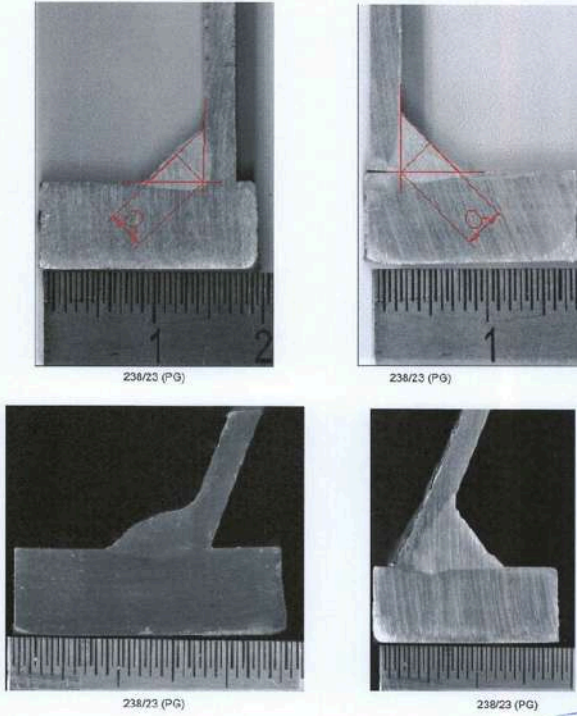

Anlage 1 Seite 1 von 1 zum Untersuchungsbericht des TÜV SÜD Industrie Service GmbH Prüf-Nr. 0036752-13-23-01-219-004



Our standards

- ◆ ISO 9001:2015
- ◆ ISO 14001:2015
- ◆ ISO 45001:2018
- ◆ Welding: ISO 3834-2
- ◆ EN 1090-2



Product groups



1. Strut Supports & Fixings



2. Pipe Supports



3. Instrument Supports



4. Excess Platforms & Stairs



5. Data Centre Equipment

1. Strut Supports & Fixings



We are equipped with various tooling to manufacture a wide range of strut support systems, cantilever arms, and complete support systems. This includes mainly standard strut ranges, but also wall- and floor-brackets, fittings & connectors. We can tailor our products to meet customer specifications regarding thickness, size, and length. Our products are available in various finishes, including plain, hot-dip galvanized, electroplated, or coated, and are made from both carbon steel and stainless steel A4.

2. Pipe Supports

We manufacture in-house pipe clamps, according to DIN 3567-A, screw clamps, fixings, adjustable sliding supports, and custom solutions of all types. We also supply heavy-duty cantilevers in various shapes and sizes for mounting these pipe clamps. In addition to pipe supports, we can provide various secondary structures and bracing.

Our pipe clamps and supports are available in plain or with a range of surface treatments, including hot-dip galvanizing or coating. Stainless Steel is available on request.



3. Instrument Supports



We manufacture instrument stands and supports in all sizes and variations, including floor-mounted supports and wall or beam-mounted instrument supports. We can also design and produce non-standard instrument supports to meet your specific requirements, with a range of surface finishes such as hot-dip galvanizing or coating. Stainless steel supports are available upon request.

4. Excess Platforms & Stairs



We offer a range of safety stairs, access platforms, gates, and railings, from simple steps to large and complex platform systems, all in compliance with and according to the EN 1090-2 regulations.

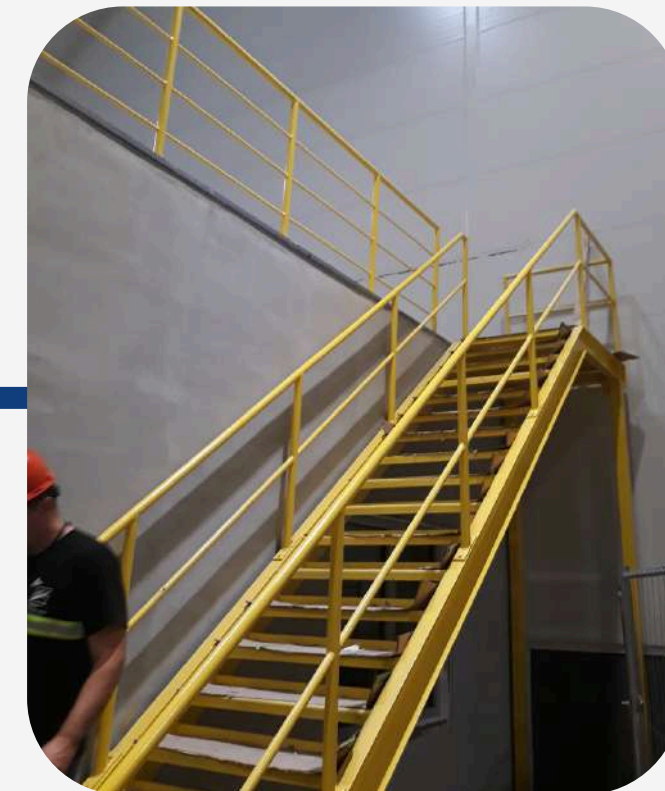

5. Data Centre Equipment

We manufacture customized M&E supports, brackets, and substructures for power distribution, cooling systems, cabling, and structural frameworks in data centers, tailored to our clients' specifications. As an OEM/private-label partner, our components are approved for major European data center projects, including GAFAM facilities.

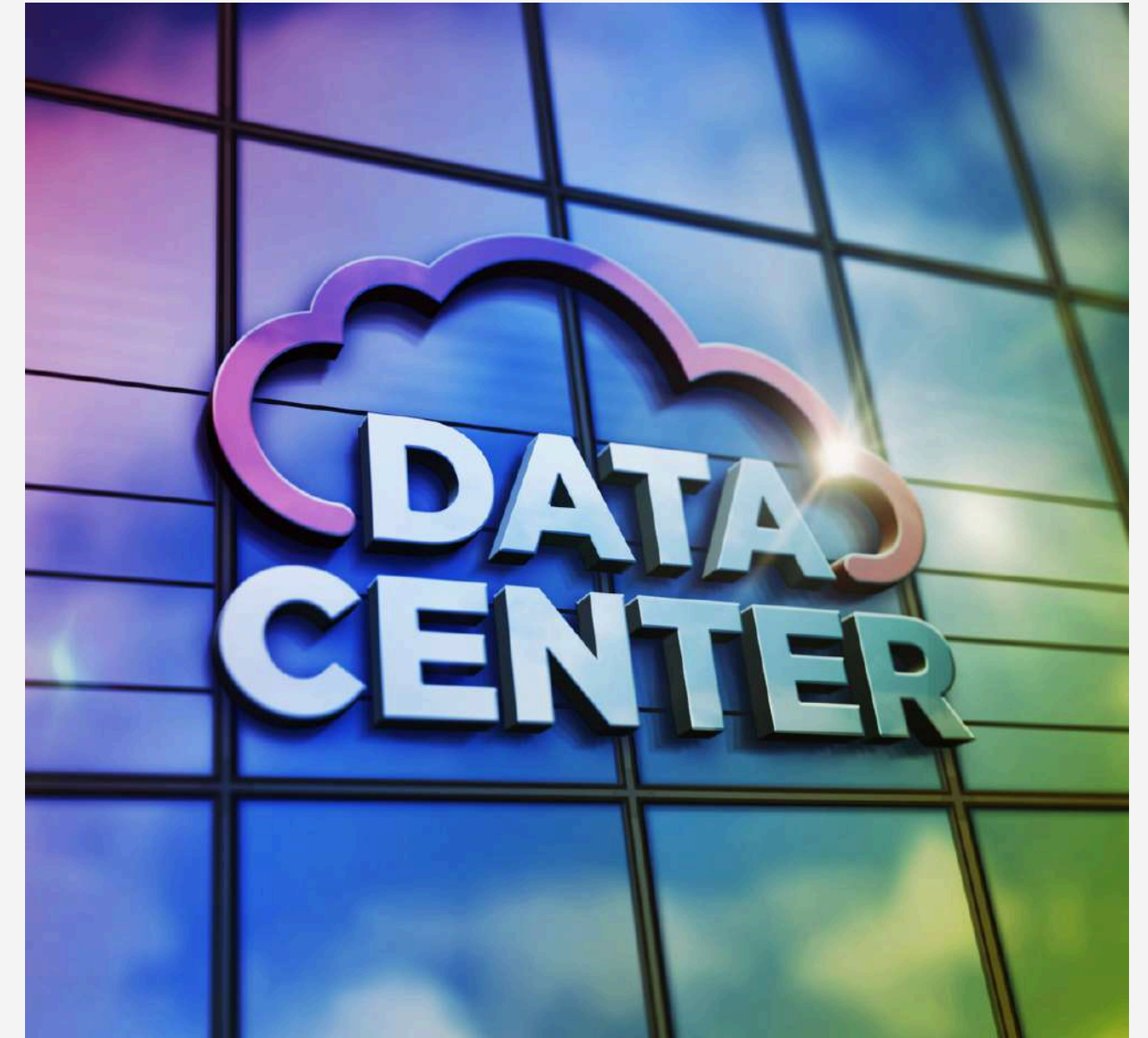

Main Surface Treatments (Carbon) STEEL

- **Hot-dip galvanizing:** Dipping metal into molten zinc for a protective coating. This is used to prevent corrosion, especially in outdoor environments. (**EN ISO 1461**)
- **Electrolytic galvanizing:** Using electrical current to apply a metal coating to the products for corrosion resistance or enhancing wear durability. (**ISO 2081**)
- **Powder Coating:** Applying powdered paint to the surface and then curing it with heat to form an even and durable coating offering a hard and resistant finish. (**ISO 8130**)
- **Protective Paint Systems** on request available.

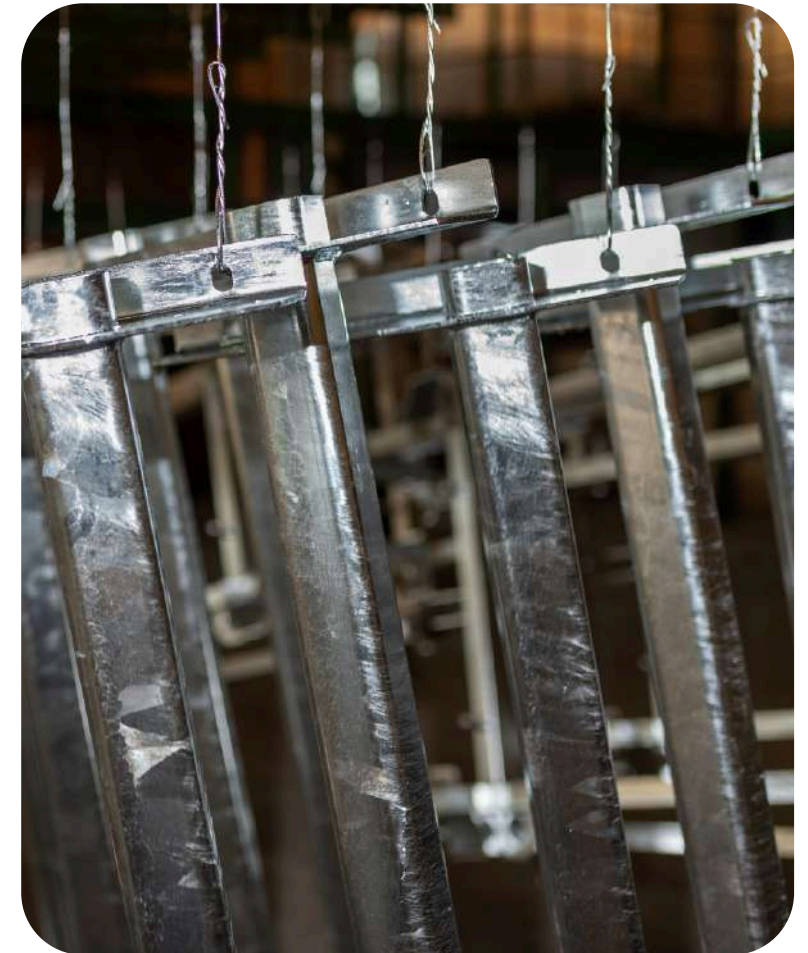

Main Surface Treatments RVS

- **Pickling:** Chemical treatment process to remove impurities, rust or scale from RVS. Typically involves soaking the metal in an acid solution, such as hydrochloric or sulfuric acid to clean and prepare surface for further treatment.
- **Passivation:** Cleaning the steel with acidic solution to remove free iron and other contaminants from the surface. This oxide layer helps to protect the product from steel from rust and corrosion. (**ISO 16048**)

Various options for corrosion protecting and paint systems with or without paint report are available in consultation with our specialized partners in the Netherlands or locally in Serbia.



Finishing & Packing

◆ Final & Visual check

Before packing, each product undergoes a final visual inspection to ensure it meets all quality standards. This guarantees that only fully compliant products are shipped, ensuring reliable, top-quality delivery.

◆ Labeling & Packing & Assabling

We label and pack as a standard procedure, but on request we can also assemble your products with hardware or pre-sort your products per box and pallet with customized packinglist. We can mark your products project based, per work area, per floor nr etc. to avoid sorting out on site.

◆ (DAP) Shipment

Shipments from a non-EU country:

Shipping from a non-EU country, like Serbia, does not cause any complications for our customers. They also have the possibility to engage customs who facilitate the transport process for a small fee per transport. As a result, our customers do not have to worry about country's laws and regulations including taxes.

ESM arranges all transport to the customer's preferred location, our customers receive all necessary export documents in one e-mail as soon as the products leave our site.



Installation & Application of Our Products



Connect with us.



Email

- tom.deboer@esm.rs
- office@esm.rs



Website

<https://esm.rs/>



Social Media

in: ESM European Strut&Support Manufacturer
IG: esm.doo



Call us

+381(0)22 671 543

